

# CUSTOMER SIGN OFF

CUSTOMER SIGNATURE: \_\_\_\_\_

PRINTED NAME: \_\_\_\_\_

TITLE: \_\_\_\_\_

DATE: \_\_\_\_\_

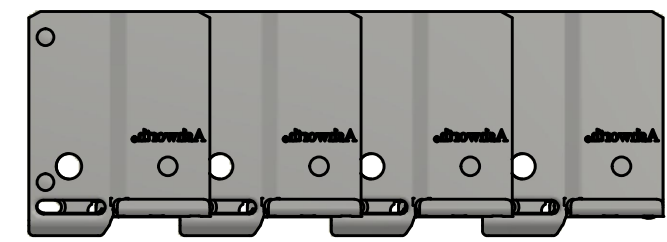
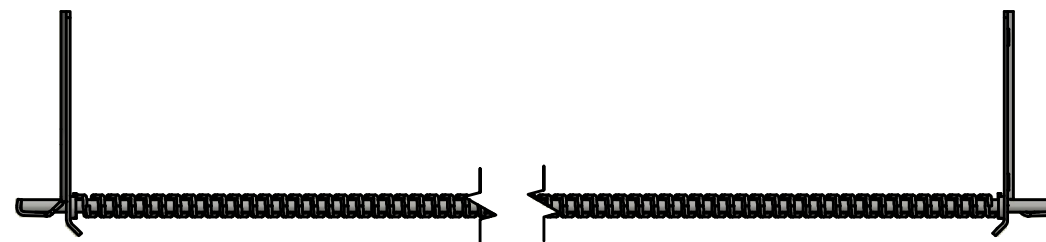
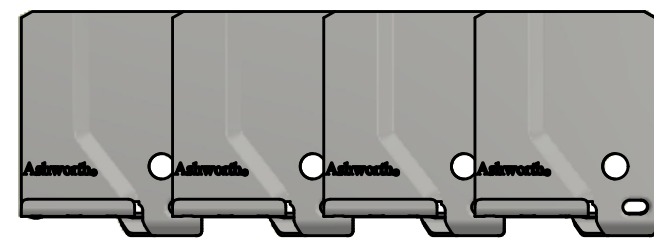
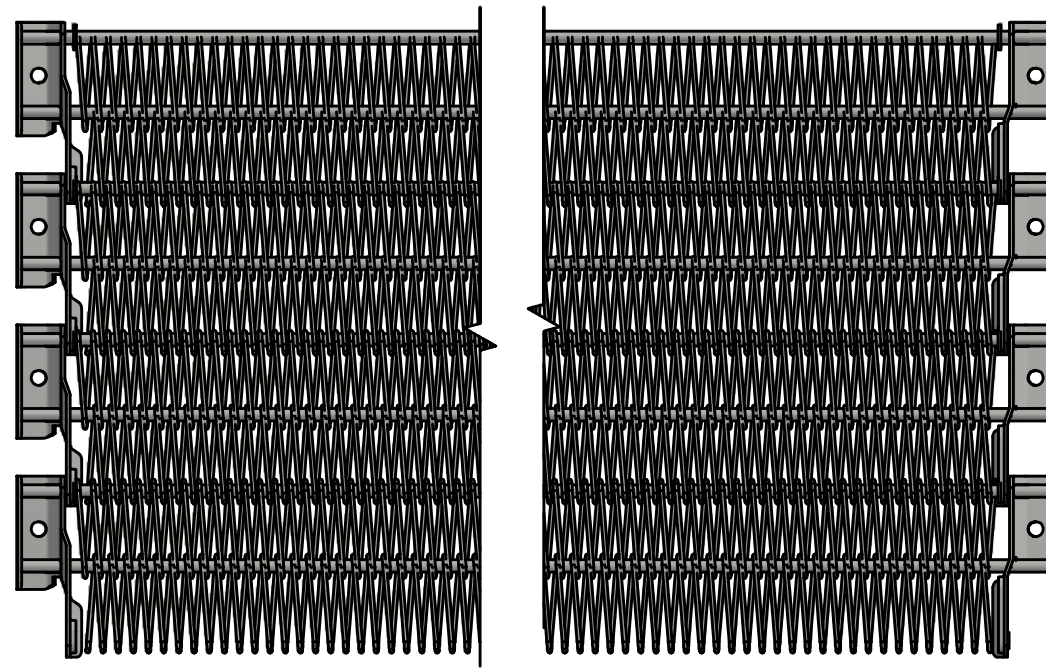

\*\*\*PIGTAILS NOT SHOWN

DO NOT SCALE DRAWING		 <b>Ashworth Bros., Inc.</b> <small>450 ARMOUR DALE, WINCHESTER, VA 22601</small>	
APPROVALS	DATE	TITLE	
DRAWN <b>witrinc</b>	1/8/2021	ILLUSTRATION, EXACTASTACK ASB, 760 BW, 76-6-1.6 [U51-10-16], 80mm LINK HEIGHT, CW	
UNLESS OTHERWISE SPECIFIED DIMENSIONS ARE IN <u>INCHES</u> . TOLERANCES: .X = ± .03      FRACTION ± 1/16 .XX = ± .015      ANGLES ± 1/2° .XXX = ± .005 .XXXX = ± .0005      SURF FINISH 63 ✓		SIZE	DWG. NO.
CAD/FILE NAME		<b>B</b>	<b>62967-1</b>
Stacker Assembly.idw		SCALE <b>1 / 3</b>	REV. <b>A</b>
		CALC.WT N/A	SHEET <b>1 OF 2</b>

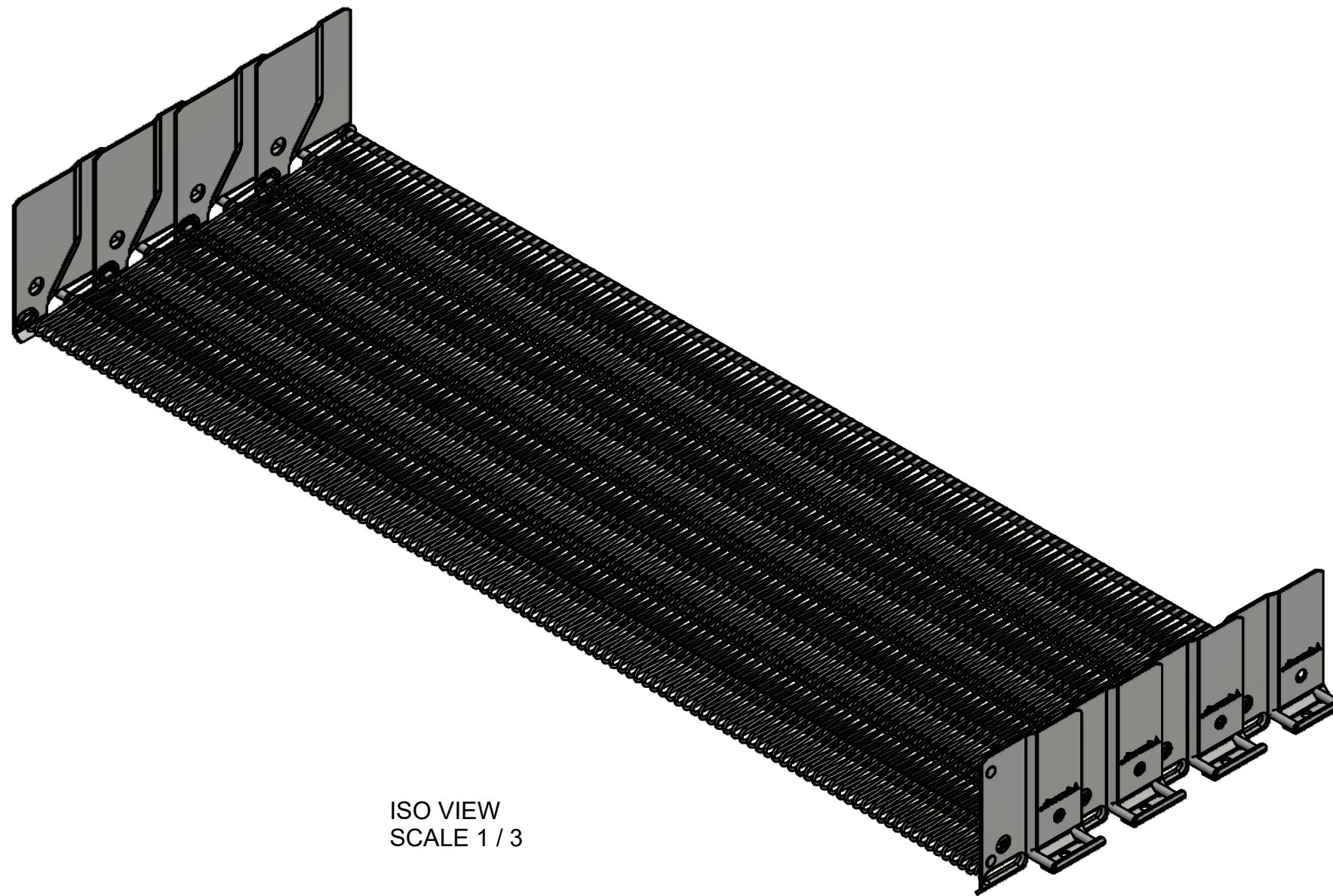

ISO VIEW  
SCALE 1 / 3

DO NOT SCALE DRAWING		 <b>Ashworth Bros., Inc.</b> <small>450 ARMOUR DALE, WINCHESTER, VA 22601</small>
APPROVALS	DATE	
DRAWN <b>witrinc</b>	1/8/2021	TITLE
UNLESS OTHERWISE SPECIFIED DIMENSIONS ARE IN <u>INCHES</u> . TOLERANCES: .X = ± .03      FRACTION ± 1/16 .XX = ± .015      ANGLES ± 1/2° .XXX = ± .005 .XXXX = ± .0005      SURF FINISH 63 ✓		<b>ILLUSTRATION, EXACTASTACK          ASB, 760 BW, 76-6-1.6 [U51-10-16],          80mm LINK HEIGHT, CW</b>
CAD/FILE NAME		SIZE
Stacker Assembly.idw		<b>B</b>
		DWG. NO.
		<b>62967-1</b>
		REV.
		<b>A</b>
		SCALE
		1 / 3
		CALC.WT
		N/A
		SHEET
		2 OF 2